

I C E - FELIX

F E L 250

F E L L A S 2505 C

User's Manual

NOTA: Acest echipament nu este destinat să funcționeze
pe liniile de comunicație aparținând M.T.Tc.

TABLE OF CONTENTS

	page
1. INTRODUCTION.....	1
1.1 General.....	1
1.2 Interfaces.....	4
1.3 Block diagram.....	5
1.4 Specifications.....	7
2. APPLICATION EXAMPLE.....	8
3. INSTALLATION.....	9
3.1 Terminal connection.....	9
3.2 Line connection.....	9
3.3 Mode of operation.....	10
3.4 Layout.....	12
3.5 Fault tracing.....	13

1. INTRODUCTION

1.1. General

The Fellas 2505 Private Network Baseband Unit is designed for low to medium speed serial data communication over inhouse or local lines. It operates at data rates of 1200, 2400, 4800, 9600 or 19200 bits/s, for synchronous mode of operation and at any speed between 0 and 19200 bits/s, for asynchronous mode of operation. Operation is full-duplex, four wires, point to point, internally or externally clocked.

The Fellas 2505 is completely independent of and transparent to data formate and protocols used.

Electrical isolation between modems is achieved by using opto-couplers. This eliminates problems caused by ground potential differences between terminals, which is common in communications networks. It also protects terminals from damages in case of occasional transients. Therefore, it is often advantageos to use Fellas 2505 modems even if distances are fairly short, e.g. 10 or 20 meters.

The Fellas 2505 modulation and transmission techniques allows a 10 km maximum distance between modems at 1200 bits/s. At higher speeds the distance have to be reduced. I.e., at 9600 bits/s the maximum distance is 3.5 km and at 19200 bits/s 2.7 km.

On the front panel of the unit there are five LED indicators. These indicators are indispensable at installation time, as a guide for operator or when trouble-shooting the communication system. The front panel indicators are summarized in table 1-1 and shown in fig.1-1.

On the rear panel of the unit there are the the AC power connector, the AC power fuse, the AC power ON-OFF switch, the V.24 interface connector, and the transmission line connectors. The rear panel is shown in fig.1-2.

FELLAS 2505-C



private network
baseband unit.

- DSR
- DTR
- RTS
- CTS
- CD

Fig. 1-1. Fellas 2505 unit front panel.

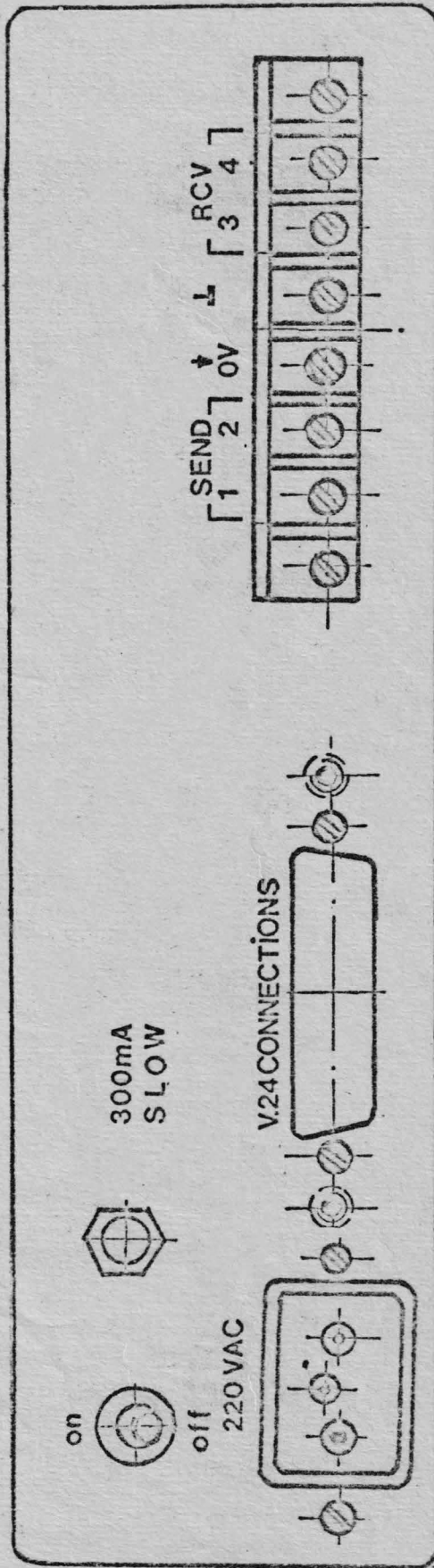

FIG. 1-2. Fellas 2505 unit rear panel.

1. Data set ready (Power On)
2. Data terminal ready
3. Request to send
4. Clear to send
5. Carrier detect

Table 1-1. LED front panel indicators.

1.2. Interfaces

The data terminal interface of the Fellas 2505 is according to EIA RS-232C or CCITT V.24 and V.28 standards. The interchange signals are summarized in table 1-2.

Pin No.	CCITT Designation	EIA RS-232C Designation	Interchange Circuit Name
1	101	AA	Protective ground
2	103	BA	Transmitted data
3	104	BB	Received data
4	105	CA	Request to send
5	106	CB	Clear to send
6	107	CC	Data set ready
7	102	AB	Signal ground
8	109	CF	Received line signal detector (carrier detect)
15	114	DB	Transmitter signal element timing (DCE Source)
17	115	DD	Receiver signal element timing
20	108/2	CD	Data terminal ready
24	113	DA	Transmitter signal element timing (DTE Source)

Table 1-2- Fellas 2505 interchange circuits by pin number.

The "transmitter signal element timing" signal can either be switch selected to be internal (pin no.15), or external (pin no.24). Internal clock speeds can be selected to be of 1200, 2400, 4800, 9600

The "transmitter signal element timing" signal can either be switch selected to be internal (pin no.15), or external (pin no.24). Internal clock speeds can be selected to be of 1200, 2400, 4800, 9600 and 19200 bits/s. Any external clock frequency up to 19200 bits/s can be used.

1.3. Block diagram

A block diagram of the Fellas 2505 is shown in fig.1-3.

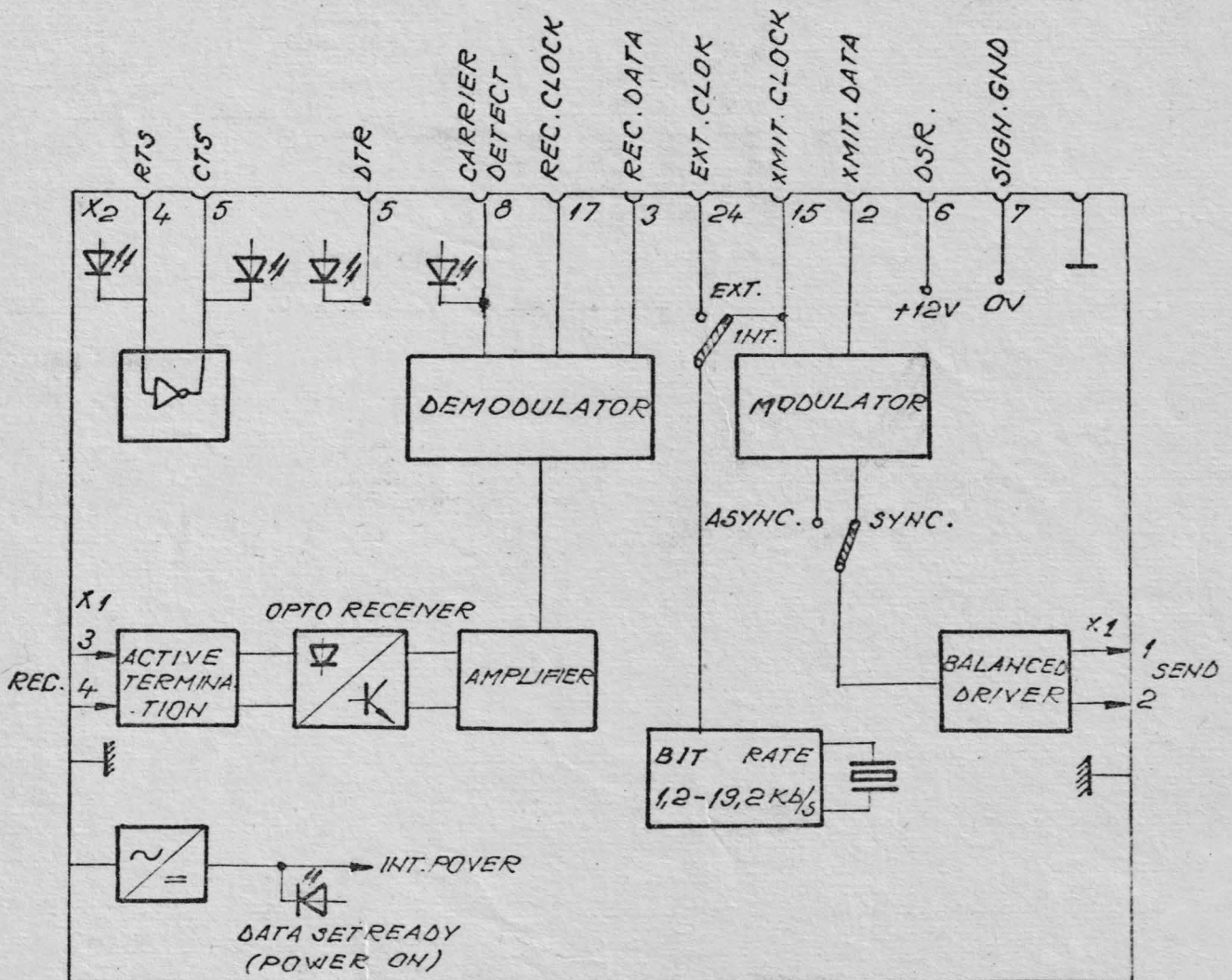

Fig.1-3. Fellas 2505 block diagram.

Connector X2 is the V.24 interface. Twelve signals are provided in this interface (ref. table 1-2).

Data Set Ready (pin 6) is ON whenever the Fellas 2505 is powered on.

Data is received from the line at pins XI.3 and XI.4. After passing the opto-receiver, the data is sent to the demodulator. The demodulator detects if the transmission line is connected and receiving a line signal from another Fellas 2505. Whenever this is true, the carrier detect signal is presented at pin 8. The demodulator also separates the clock (pin 17) from the Received Data (pin 3).

From the modulator, one can select either the Synchronous or the Asynchronous mode of operation.

As shown in the block diagram, one can select either external (clock from the terminal) or internal clocking. The Fellas 2505 accepts any external clock (pin 24) rate up to 19200 bits/s. The internal clock (pin 15) is controlled by an 4.9152 MHz crystal oscillator. Selectable bit rates for synchronous operation are 1200, 2400, 4800, 9600 and 19200 bits/s. For asynchronous operation any data rate from 0 up to 19200 bits/s is available.

From the driver output, two switches are provided for using long or short transmission lines. A short line is defined as a line with a total resistance (both ways) up to 600 ohms. A long line is defined as a line with a total resistance between 600 ohms and 1 kohms.

The current through the optocouplers' LEDs can be adjusted to a specified value (20 mA) by means of a trimmer resistor (P1).

1.4. Specifications

Interface	According to EIA RS232-C and CCITT V.24/V.28 (see table 1-2)										
Transmission Configuration	Synchronous, asynchronous, full duplex Point-to-point										
Data format	Transparent to data formats										
Speed	1200, 2400, 4800, 9600, 19200 bits/s, (strap-selectable)-synchronous 0 ± 19200 bits/s - asynchronous										
Clock	Internal or external (switch selectable)										
Clear to send delay	0 ms										
Line interface	±20 mA opto-isolated balanced current loops										
Line distance	<table> <tr> <td>19200</td> <td>9600</td> <td>4800</td> <td>2400</td> <td>1200bits/s</td> </tr> <tr> <td>2.7</td> <td>3.5</td> <td>5</td> <td>7</td> <td>10 km</td> </tr> </table> <p>Note: If shielded cable is used, distances should be reduced by factor of 3.</p>	19200	9600	4800	2400	1200bits/s	2.7	3.5	5	7	10 km
19200	9600	4800	2400	1200bits/s							
2.7	3.5	5	7	10 km							
Front panel indicator (see table 1-1)	Data set ready Data terminal ready Request to send Clear to send Carrier detect										
Dimensions	250x176x80 mm										
Weight	2 kg										
Power	220 VAC; +10/-15%; 50/60 Hz										
Temperature range	5° ± 40°C										
Humidity	0 - 80% RH, non-condensing.										

2. APPLICATION EXAMPLE

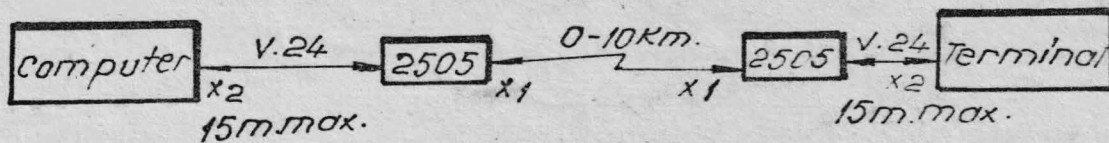
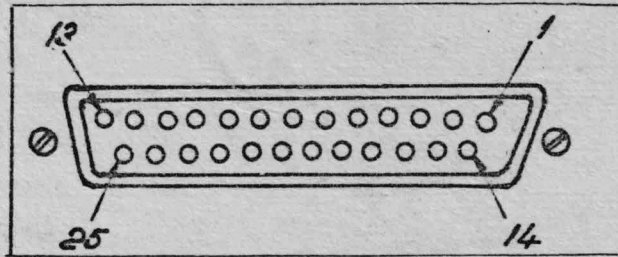

Fig.2-1. Point-to-point connection between computer and terminal.

3. Installation

3.1. Terminal connection

The terminal must be connected according to section 1.2. The maximum cable length is 15 m. The V.24 interface connector is shown in fig. 3-1.



25-Pin female connector, pin numbering convention.

Fi. Fig.3-1. V.24 interface connector.

3.2. Transmission line connection

The transmission lines between two Fellas 2505 units should be connected according to fig.3-2. One communication line requires four wires.

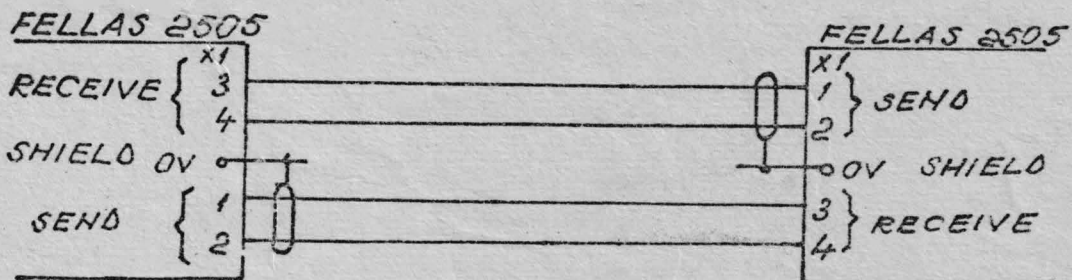

Fig.3-2. Transmission line connection.

A cable consisting of two twisted pairs is recommended. When RFI protection is needed a shielded cable should be used. If so, just connect the shield at one end of the transmission line. The same is recommended even if the pairs have a common shield.

3.3 Mode of operation selection

All switches are located on the PC board of the Fellas 2505-C unit (see fig. 3-3). Access to the PC board is possible after loosening the four screws on the bottom cover of the unit and removal of the top cover.

The synchronous/asynchronous mode of operation can be selected from MC2 switch. For asynchronous mode of operation, the MC2 switch must be set on "A" position. For synchronous mode of operation the MC2 switch must be set on "S" position.

For synchronous mode of operation, internal clock is selected with MC1 switch on "I" position. The external clock is selected with MC1 switch on "E" position.

The internal clock speeds can be selected with switches I2, I3, I4. From the left to the right (see fig. 3-3) the speeds correspond in order: 38.4; 19.2; 9.6; 4.8; 2.4; 1.2 kbps. The speed is selected by positioning the corresponding switch on the "ON" position.

Only one switch must be set on the "ON" position at one time!

The I1 double switch selects a long line (line resistance greater than 600) on the "OFF" position and a short line (line resistance smaller than 600) on the "ON" position.

CAUTION

Disconnect the power cord before removing the top cover!

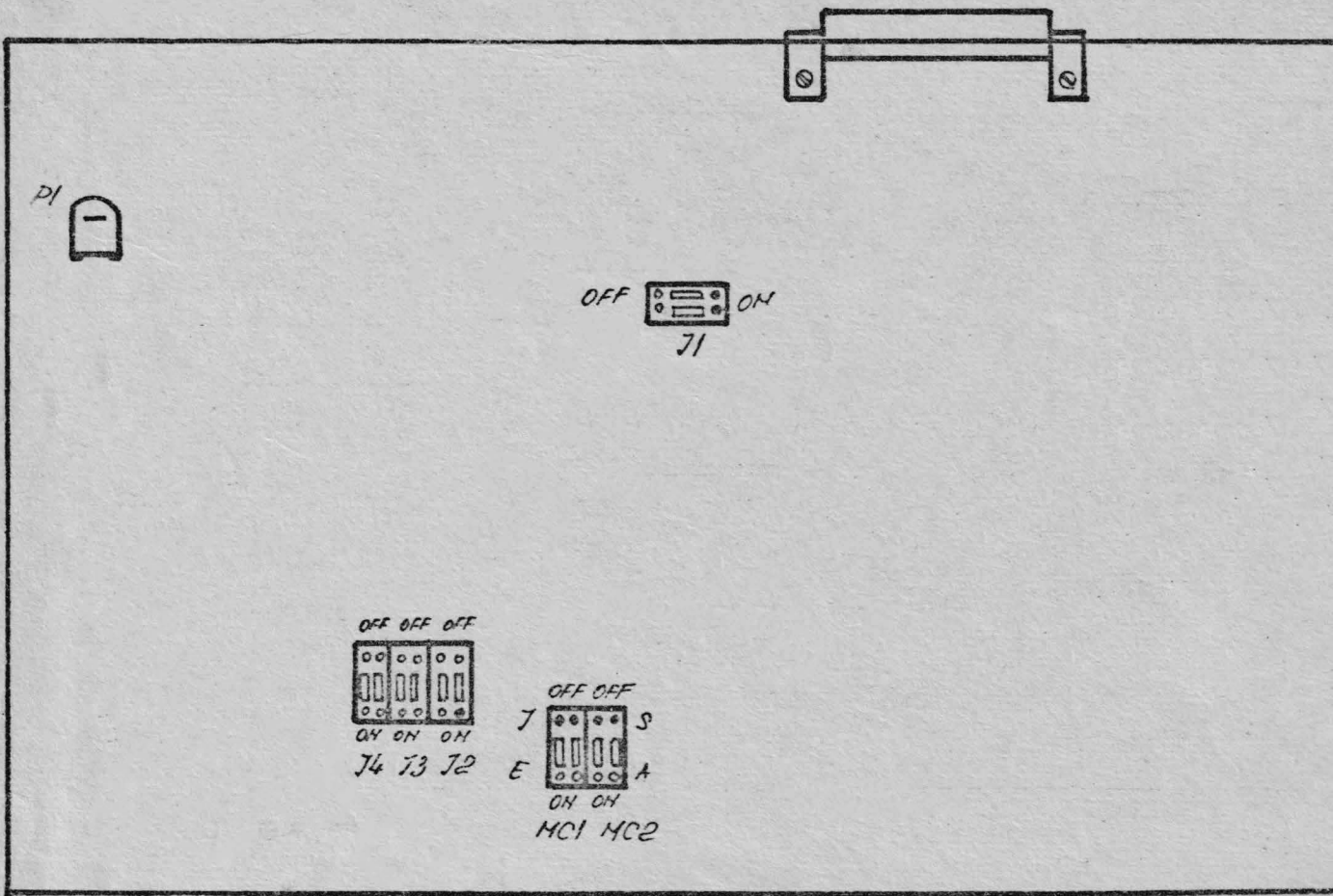

Fig. 3-3. Bellas 2505-C unit PC board.

Switch and strap locations.

(In this figure the unit is set on synchronous mode of operation, internal clock-1200bits/s., long line.)

3.4. Layout

The Fellas 2505 unit is a small desk top model and is easily installed. The following points apply during installation:

- * A maximum of 6 units may be mounted on a dedicated rack.
- * Provide sufficient space for operation on the front and rear sides for cable connections. For desk-top placement, reserve approximately 20 cm for operation at the front and rear panels, checking indicator lamps and cables. Reserve approximately 10 cm at both sides for ventilation. When mounting on a rack, provide approximately 1 m space at the front for drawing out the unit. Allow sufficient space for cables at the rear side of the unit.
- * The ambient temperature should be $0^{\circ}\text{C} \pm 40^{\circ}\text{C}$, and the humidity should be 80% or less. The Fellas 2505 unit
- * must be protected from direct sun rays, mechanical vibrations and dust.

3.5 Fault tracing

When tracing a fault the front panel light emitting diodes (LED) and the following chart can be of great help.

<u>Symptom</u>	<u>Possible fault</u>
Data Set Ready indicator not lit	<ol style="list-style-type: none"> 1. No power. 2. Faulty line fuse in Fellas 250 3. Faulty power supply fuse in Fellas 2505.
No received data	<ol style="list-style-type: none"> 1. Other terminal not transmitting 2. Line incorrectly connected. 3. Faulty line.
Errors in received data	<ol style="list-style-type: none"> 1. Speed strapping incorrect. 2. Transmitting terminal has incorrect transmission speed. 3. Faulty terminal. 4. Transmission line too long. 5. Interference with other equipments.
Impossible to transmit data	<ol style="list-style-type: none"> 1. No Request to Send from terminal. 2. Clear to Send circuit faulty. 3. Synchronous/Asynchronous switch incorrectly set. 4. Internal/External clock switch incorrectly set.
Errors in transmitted data	<ol style="list-style-type: none"> 1. Line incorrectly connected. 2. Speed strapping incorrect. 3. Receiving or transmitting terminal faulty. 4. Transmission line too long. 5. Interference with other equipments.

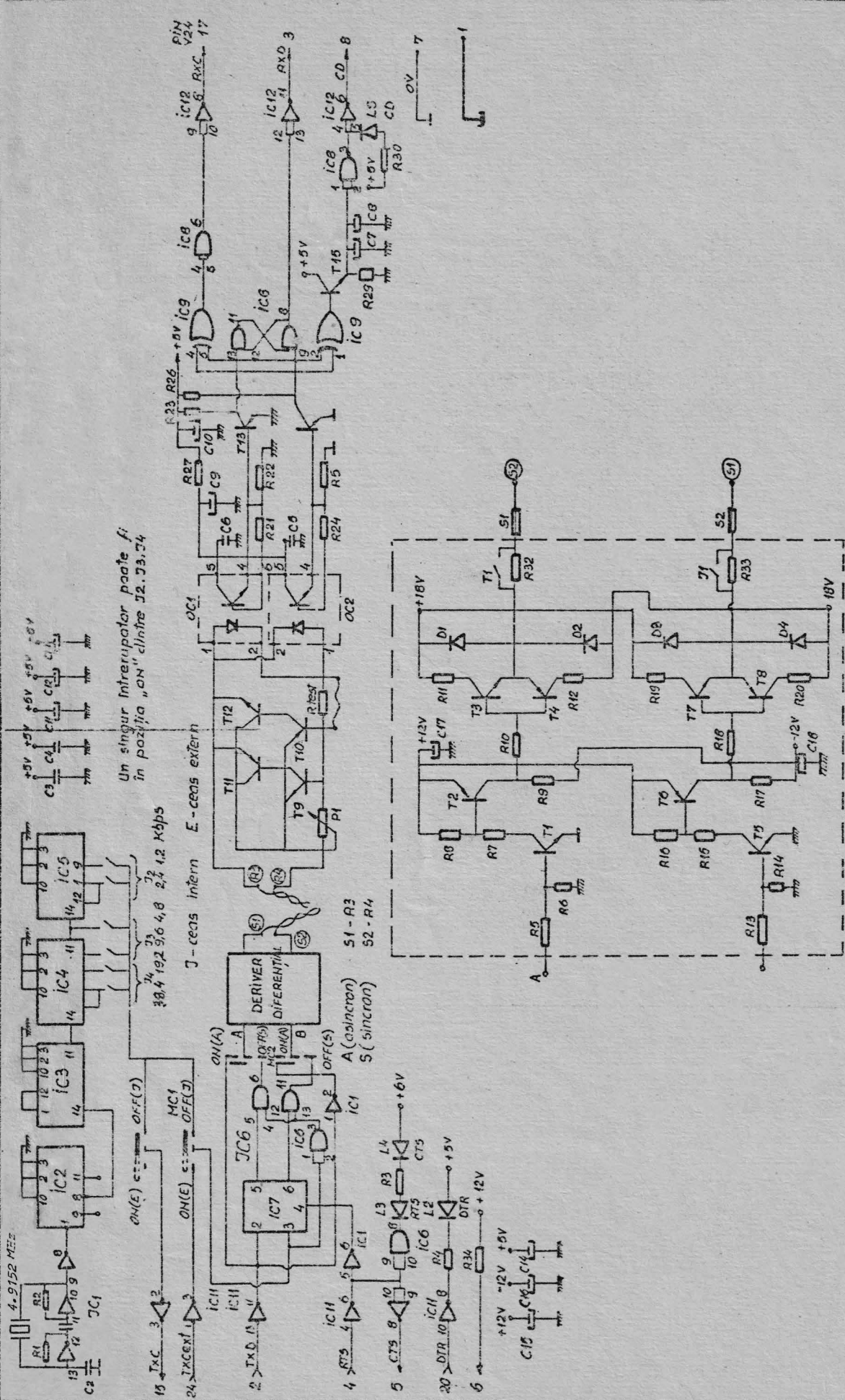

DRIVER DIFERENTIAL
2505C - Schematic diagram